



GREENCREATIVE

Bringing You the Latest in LED Technology



2015 SPRING PRODUCT CATALOG



GREEN CREATIVE is a 5-year-old solid state lighting development and manufacturing company based in Silicon Valley, CA. The company offers a comprehensive line of high-performance LED lighting solutions which has been widely adopted by some of the largest companies in the world.



Bringing you the latest in LED technology
Anchored by strong integrated R&D capabilities, GREEN CREATIVE innovation, performance and reliability have been recognized year after year by the Illuminating Engineering Society Progress Report and the LEDs Magazine Sapphire Awards.



A complete line with national distribution
GREEN CREATIVE's full product line of ENERGY STAR, DLC and CEC certified indoor retrofit and new construction lighting solutions serves the Retail, Hospitality, Food & Beverage, Office and Education industries through multiple distribution centers and sales networks across the USA.

GREEN CREATIVE FULL PRODUCT FAMILY

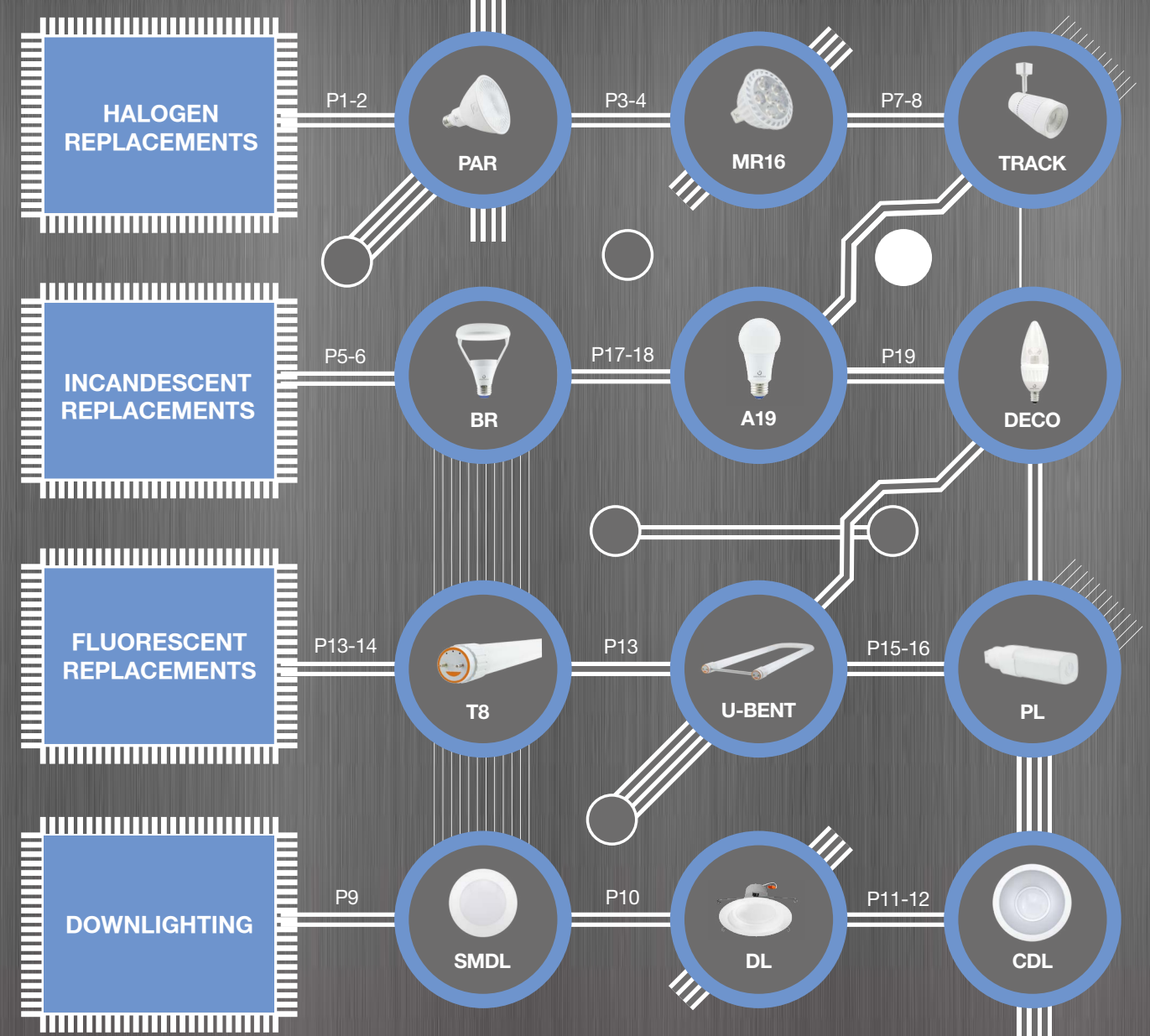



True 75W Halogen Replacement

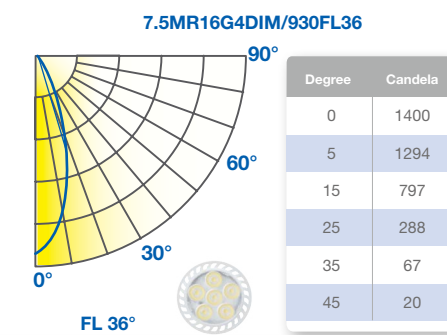
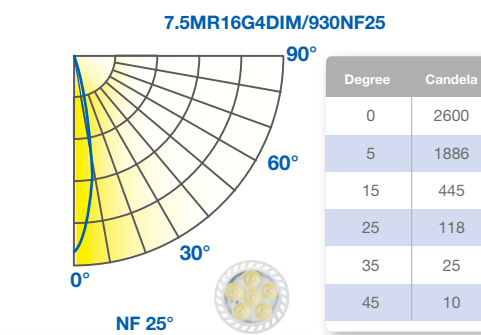
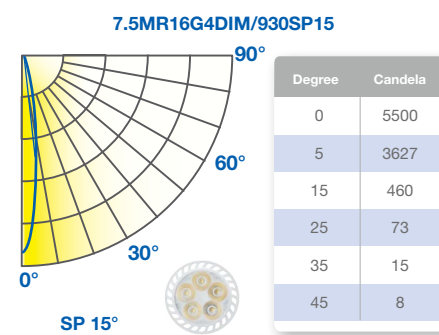

MR16 7.5W - High CRI

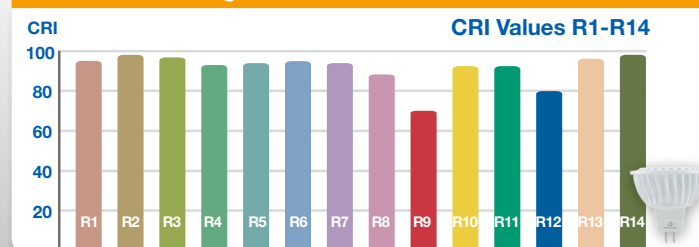

- Most efficient high CRI MR16 75W halogen replacement
- Exceptional color rendering CRI 92
- Richer reds and natural skin tones (R9 70, R13 96)
- Suitable for use in totally enclosed fixtures

SPECIFICATIONS*

Model	Product	CCT	Lumens (lm)	Equiv.	LPW	Beam Angle	CBCP (cd)	CRI (typ.)	Dim	Life (hrs)	Voltage	Encl.	Energy Star	
MR16 7.5W	7.5MR16G4DIM/927SP15	40804	2700K	410	75W	55	15°	5500	92	Yes	25,000	12V	Yes	June
	7.5MR16G4DIM/927NF25	40805	2700K	485	75W	63	25°	2600	92	Yes	25,000	12V	Yes	June
	7.5MR16G4DIM/927FL36	40806	2700K	485	75W	63	36°	1400	92	Yes	25,000	12V	Yes	June
	7.5MR16G4DIM/930SP15	40807	3000K	430	75W	57	15°	5500	92	Yes	25,000	12V	Yes	June
	7.5MR16G4DIM/930NF25	40808	3000K	505	75W	66	25°	2600	92	Yes	25,000	12V	Yes	June
	7.5MR16G4DIM/930FL36	40809	3000K	505	75W	66	36°	1400	92	Yes	25,000	12V	Yes	June
	7.5MR16G4DIM/840SP15	40810	4000K	485	75W	65	15°	5700	82	Yes	25,000	12V	Yes	June
	7.5MR16G4DIM/840NF25	40811	4000K	625	75W	81	25°	2800	82	Yes	25,000	12V	Yes	June
7.5MR16G4DIM/840FL36	40812	4000K	625	75W	81	36°	1600	82	Yes	25,000	12V	Yes	June	
MR16 7W	7MR16G3DIM/827NF25	95339	2700K	500	45W	71	25°	2325	80	Yes	25,000	12V	No	✓
	7MR16G3DIM/830NF25	95337	3000K	525	50W	75	25°	2350	80	Yes	25,000	12V	No	✓
	7MR16G3DIM/840NF25	95341	4000K	550	50W	79	25°	2400	80	Yes	25,000	12V	No	✓
MR16 7W	7MR16G4DIM/824FL36	40757	2400K	475	50W	68	36°	1180	80	Yes	25,000	12V	Yes	N.A.
	7MR16G4DIM/827FL36	40758	2700K	525	50W	75	36°	1255	80	Yes	25,000	12V	Yes	✓
	7MR16G4DIM/830FL36	40759	3000K	560	50W	80	36°	1265	80	Yes	25,000	12V	Yes	✓
	7MR16G4DIM/840FL36	40760	4000K	580	50W	83	36°	1285	80	Yes	25,000	12V	Yes	✓

SPECIFICATIONS

Model	Product	CCT	Lumens (lm)	Equiv.	LPW	Beam Angle	CBCP (cd)	CRI (typ.)	Dim	Life (hrs)	Voltage	Encl.	Energy Star	
MR16 6W	6MR16G4DIM/827FL36	40755	2700K	425	35W	71	36°	900	80	Yes	25,000	12V	Yes	✓
	6MR16G4DIM/830FL36	40756	3000K	450	35W	75	36°	925	80	Yes	25,000	12V	Yes	✓
MR16 4W	4MR16G4/827FL36	40721	2700K	270	20W	68	36°	635	80	No	25,000	12V	Yes	✓
	4MR16G4/830FL36	40720	3000K	270	20W	68	36°	635	80	No	25,000	12V	Yes	✓
GU10 6W	6GU10G4DIM/827FL36	40716	2700K	425	50W	71	36°	900	80	Yes	25,000	120V	Yes	✓
	6GU10G4DIM/830FL36	40717	3000K	450	50W	75	36°	925	80	Yes	25,000	120V	Yes	✓
PAR16 6W	6PAR16G4DIM/827FL36	40723	2700K	425	60W	71	36°	900	80	Yes	25,000	120V	Yes	✓
	6PAR16G4DIM/830FL36	40724	3000K	450	60W	75	36°	925	80	Yes	25,000	120V	Yes	✓
MR11 3W	3MR11G4/827NF30	40713	2700K	200	20W	67	30°	600	80	No	25,000	12V	Yes	N.A.
	3MR11G4/840NF30	40715	4000K	220	20W	73	30°	620	80	No	25,000	12V	Yes	N.A.

* MR16 7.5W specification data is preliminary and may be subject to change

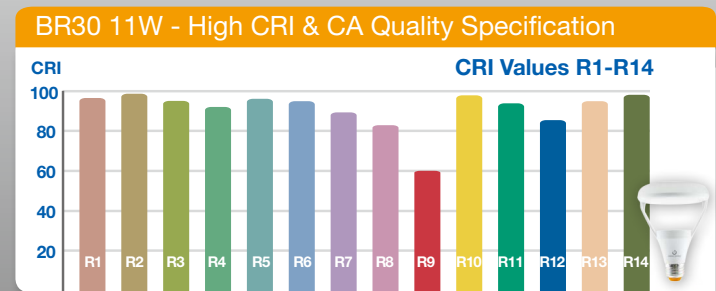

- Revolutionary CLOUD design
- 60% lighter due to environmentally friendly construction
- Smooth dimming with existing installations
- Suitable for use in totally enclosed fixtures

SPECIFICATIONS

Model	Product	CCT	Lumens (lm)	Equiv.	LPW	Beam Angle	CBCP (cd)	CRI (typ.)	Dim	Life (hrs)	Voltage	Encl.	ENERGY STAR	
BR40 14W	14BR40G4DIM/827	40636	2700K	1065	85W	76	110°	N.A.	82	Yes	25,000	120V	Yes	✓
	14BR40G4DIM/830	40637	3000K	1100	85W	79	110°	N.A.	82	Yes	25,000	120V	Yes	✓
BR40 9W	9BR40G4DIM/824	40626	2400K	650	65W	72	110°	N.A.	80	Yes	25,000	120V	Yes	N.A.
	9BR40G4DIM/827	40627	2700K	700	65W	78	110°	N.A.	82	Yes	25,000	120V	Yes	✓
BR30 8W	8BR30G4DIM/824	40770	2400K	585	65W	73	110°	N.A.	80	Yes	25,000	120V	Yes	N.A.
	8BR30G4DIM/827	40771	2700K	650	65W	81	110°	N.A.	82	Yes	25,000	120V	Yes	✓
	8BR30G4DIM/830	40772	3000K	685	65W	86	110°	N.A.	82	Yes	25,000	120V	Yes	✓
	8BR30G4DIM/840	40773	4000K	710	65W	89	110°	N.A.	82	Yes	25,000	120V	Yes	✓

SPECIFICATIONS

Model	Product	CCT	Lumens (lm)	Equiv.	LPW	Beam Angle	CBCP (cd)	CRI (typ.)	Dim	Life (hrs)	Voltage	Encl.	ENERGY STAR	
BR30 7.5W	7.5BR30G4/827	40774	2700K	650	65W	87	110°	N.A.	82	No	25,000	120V	Yes	✓
BR30 11W	11BR30G4DIM/927	40644	2700K	750	65W	68	110°	N.A.	92	Yes	25,000	120V	Yes	✓
BR30 11W GU24	11BR30G4DIM/927/GU24	40646	2700K	750	65W	68	110°	N.A.	92	Yes	25,000	120V	Yes	✓
R20 6.5W	6.5R20G4DIM/824	40611	2400K	450	45W	69	110°	N.A.	80	Yes	25,000	120V	Yes	N.A.
	6.5R20G4DIM/827	40612	2700K	500	45W	77	110°	N.A.	82	Yes	25,000	120V	Yes	✓

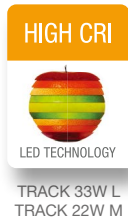

Interchangeable Lens Options (TRACK L & M)

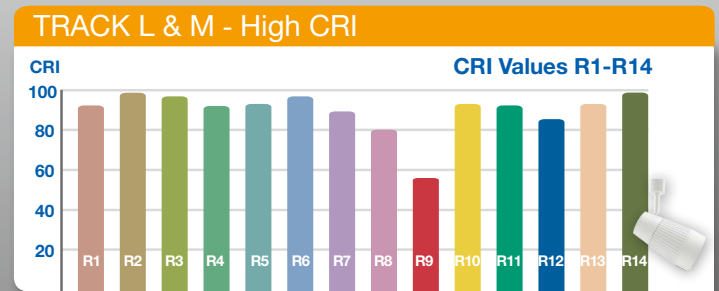
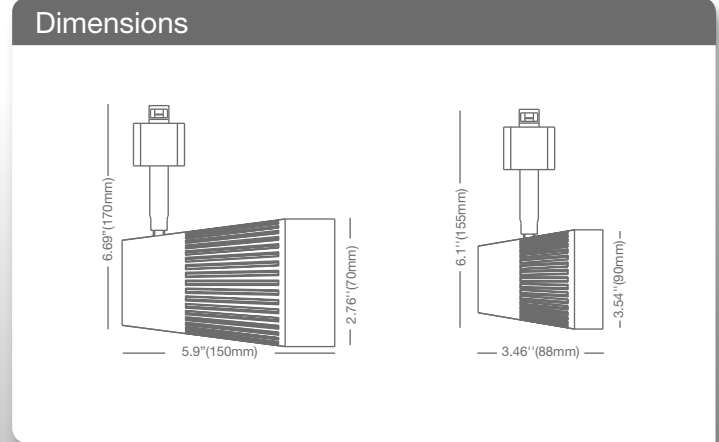
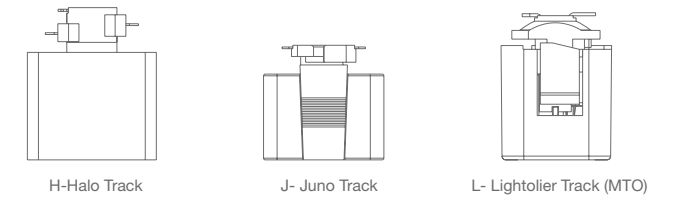
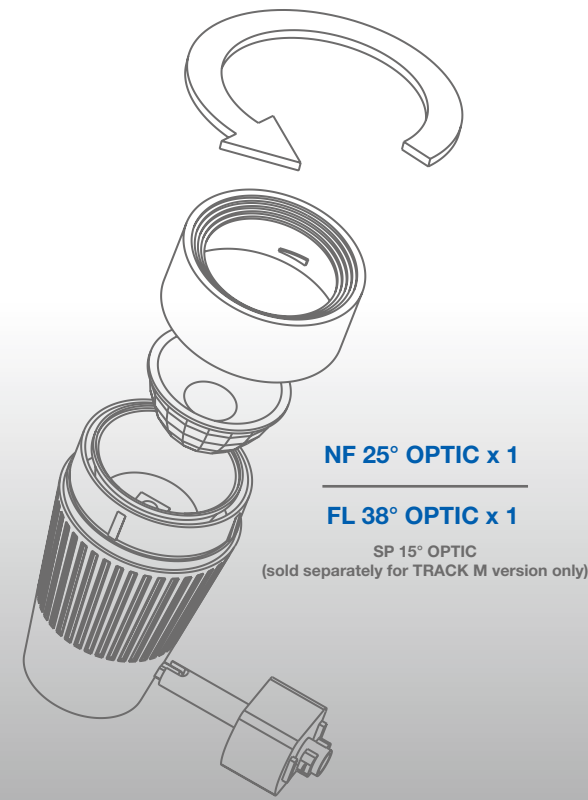

- Exceptional color rendering CRI 90
- Tight LED binning – 4-step Macadam ellipse
- Sleek design, integrated driver
- 350° horizontal and 90° vertical adjustment

SPECIFICATIONS*

Model	Product	CCT	Lumens (lm)	Equiv.	LPW	Beam Angle	CBCP (cd)	CRI (typ.)	Dim	Life (hrs)	Voltage	ENERGY STAR	
TRL 33W	33TRLG4DIM/927/W/H	97623	2700K	2200	39W HID	65	25°/38°	10,000/5150	90	Yes	40,000	120V	✓
	33TRLG4DIM/930/W/H	97629	3000K	2300	39W HID	68	25°/38°	10,350/5250	90	Yes	40,000	120V	✓
	33TRLG4DIM/927/W/J	97624	2700K	2200	39W HID	65	25°/38°	10,000/5150	90	Yes	40,000	120V	✓
	33TRLG4DIM/930/W/J	97630	3000K	2300	39W HID	68	25°/38°	10,350/5250	90	Yes	40,000	120V	✓
	33TRLG4DIM/927/B/H •	97626	2700K	2200	39W HID	65	25°/38°	10,000/5150	90	Yes	40,000	120V	✓
	33TRLG4DIM/930/B/H •	97632	3000K	2300	39W HID	68	25°/38°	10,350/5250	90	Yes	40,000	120V	✓
	33TRLG4DIM/927/B/J •	97627	2700K	2200	39W HID	65	25°/38°	10,000/5150	90	Yes	40,000	120V	✓
	33TRLG4DIM/930/B/J •	97633	3000K	2300	39W HID	68	25°/38°	10,350/5250	90	Yes	40,000	120V	✓
TRM 22W	22TRMG4DIM/927/W/H	97587	2700K	1200	20W HID	55	25°/38°/15°	6300/3250/12,200	90	Yes	40,000	120V	June
	22TRMG4DIM/930/W/H	97599	3000K	1250	20W HID	57	25°/38°/15°	6700/3450/13,000	90	Yes	40,000	120V	June
	22TRMG4DIM/927/W/J	97588	2700K	1200	20W HID	55	25°/38°/15°	6300/3250/12,200	90	Yes	40,000	120V	June
	22TRMG4DIM/930/W/J	97600	3000K	1250	20W HID	57	25°/38°/15°	6700/3450/13,000	90	Yes	40,000	120V	June
	22TRMG4DIM/927/B/H •	97590	2700K	1200	20W HID	55	25°/38°/15°	6300/3250/12,200	90	Yes	40,000	120V	June
	22TRMG4DIM/930/B/H •	97602	3000K	1250	20W HID	57	25°/38°/15°	6700/3450/13,000	90	Yes	40,000	120V	June
	22TRMG4DIM/927/B/J •	97591	2700K	1200	20W HID	55	25°/38°/15°	6300/3250/12,200	90	Yes	40,000	120V	June
	22TRMG4DIM/930/B/J •	97603	3000K	1250	20W HID	57	25°/38°/15°	6700/3450/13,000	90	Yes	40,000	120V	June

* Specification data is preliminary and may be subject to change
• Black finish

SPECIFICATIONS*

Model	Product	CCT	Lumens (lm)	Equiv.	LPW	Beam Angle	CBCP (cd)	CRI (typ.)	Dim	Life (hrs)	Voltage	ENERGY STAR	
TRS 8W	8TRSG4DIM/827NF30/W/H	16340	2700K	600	75W Hal	68	30°	1905	80	Yes	40,000	120V	✓
	8TRSG4DIM/830NF30/W/H	16346	3000K	625	75W Hal	71	30°	1950	80	Yes	40,000	120V	✓
	8TRSG4DIM/827NF30/W/J	16341	2700K	600	75W Hal	68	30°	1905	80	Yes	40,000	120V	✓
	8TRSG4DIM/830NF30/W/J	16347	3000K	625	75W Hal	71	30°	1950	80	Yes	40,000	120V	✓
	8TRSG4DIM/827NF30/B/H •	16343	2700K	600	75W Hal	68	30°	1905	80	Yes	40,000	120V	✓
	8TRSG4DIM/830NF30/B/H •	16349	3000K	625	75W Hal	71	30°	1950	80	Yes	40,000	120V	✓
	8TRSG4DIM/827NF30/B/J •	16344	2700K	600	75W Hal	68	30°	1905	80	Yes	40,000	120V	✓
	8TRSG4DIM/830NF30/B/J •	16350	3000K	625	75W Hal	71	30°	1950	80	Yes	40,000	120V	✓

* Specification data is preliminary and may be subject to change
• Black finish

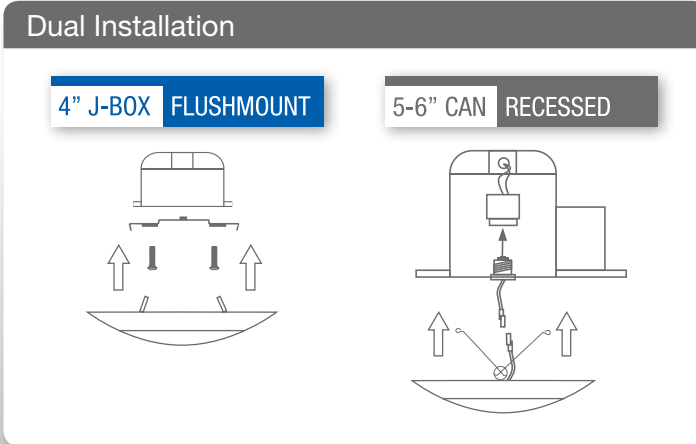
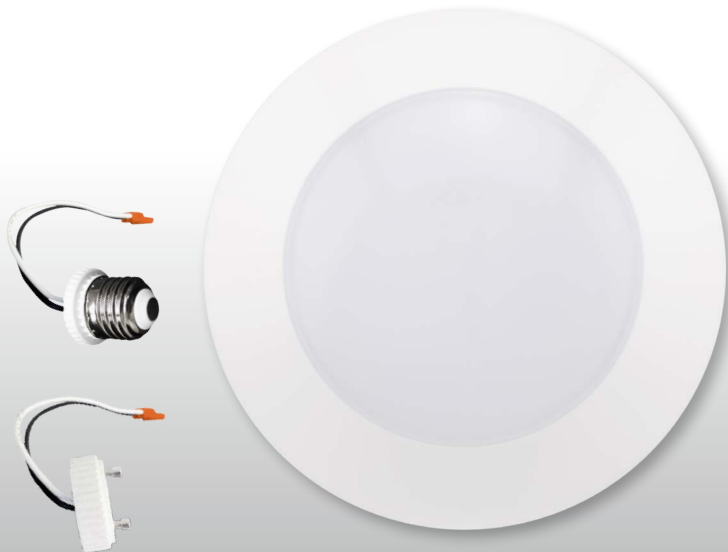
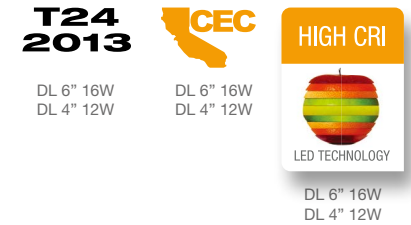

- Innovative CLICK design
- Fits most 4" J-boxes and 5-6" recessed housings
- Installs in just minutes - no rewiring
- Exceptional color rendering CRI 90



- Compatible with most 6" or 4" housings
- Installs in just minutes - no rewiring
- Smooth dimming with existing dimmers
- GU24 connector available

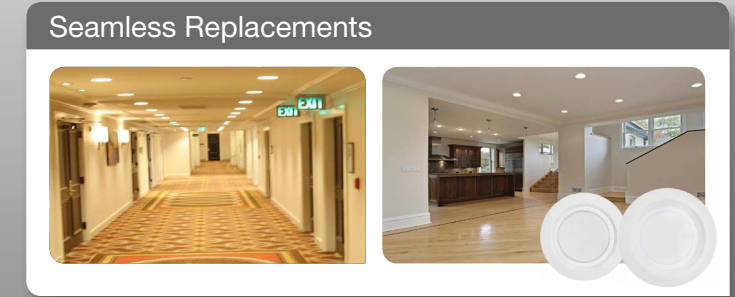
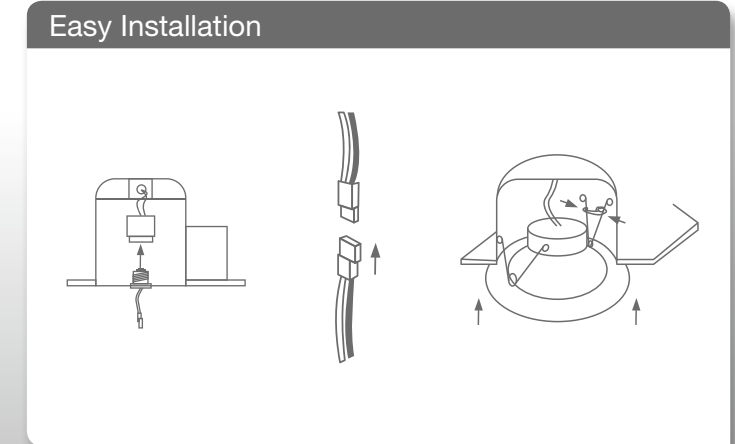



SPECIFICATIONS*														
Model	Product	CCT	Lumens (lm)	Equiv.	LPW	Beam Angle	CBCP (cd)	CRI (typ.)	Dim	Life (hrs)	Voltage	Encl.		
	14.5SMDL6G4DIM/927	40842	2700K	950	75W	66	110°	N.A.	90	Yes	40,000	120V	No	June
	14.5SMDL6G4DIM/930	40843	3000K	950	75W	66	110°	N.A.	90	Yes	40,000	120V	No	June
	14.5SMDL6G4DIM/840	40847	4000K	1150	85W	79	110°	N.A.	80	Yes	40,000	120V	No	June
	10SMDL4G4DIM/927	40833	2700K	600	50W	60	110°	N.A.	90	Yes	40,000	120V	No	June
	10SMDL4G4DIM/930	40834	3000K	625	50W	63	110°	N.A.	90	Yes	40,000	120V	No	June

SPECIFICATIONS														
Model	Product	CCT	Lumens (lm)	Equiv.	LPW	Beam Angle	CBCP (cd)	CRI (typ.)	Dim	Life (hrs)	Voltage	Encl.		
	16DL6G3DIM/927	40710	2700K	800	75W	50	110°	N.A.	92	Yes	35,000	120V	No	✓
	16DL6G3DIM/930	40711	3000K	850	75W	53	110°	N.A.	92	Yes	35,000	120V	No	✓
	12DL6G3DIM/827	40695	2700K	750	75W	63	110°	N.A.	82	Yes	35,000	120V	No	✓
	12DL6G3DIM/830	40696	3000K	800	75W	67	110°	N.A.	82	Yes	35,000	120V	No	✓
	12DL4G3DIM/927	40712	2700K	600	50W	50	110°	N.A.	92	Yes	35,000	120V	No	✓
	11DL4G3DIM/827	40697	2700K	620	60W	56	110°	N.A.	82	Yes	35,000	120V	No	✓

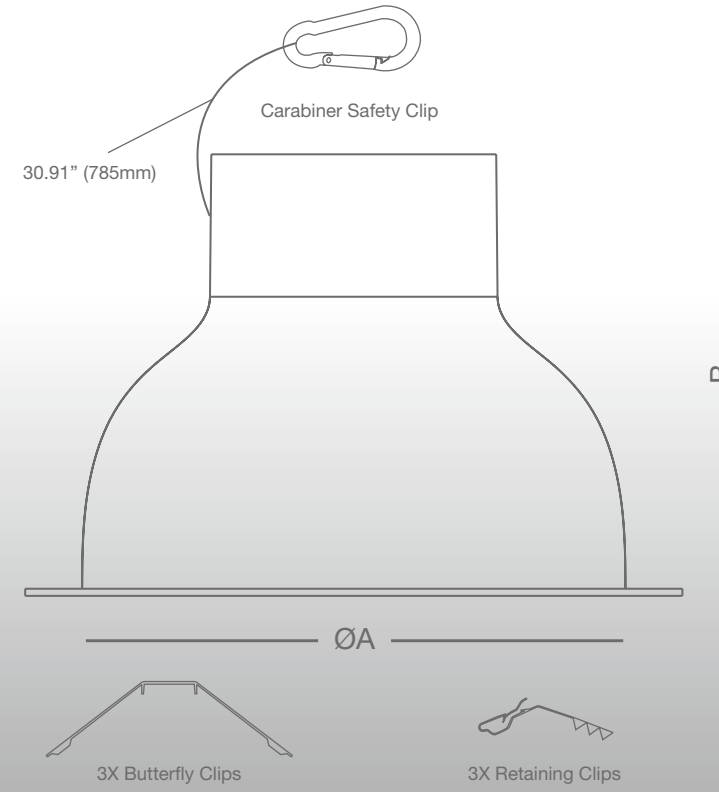
* Specification data is preliminary and may be subject to change
 ** GU24 connector available





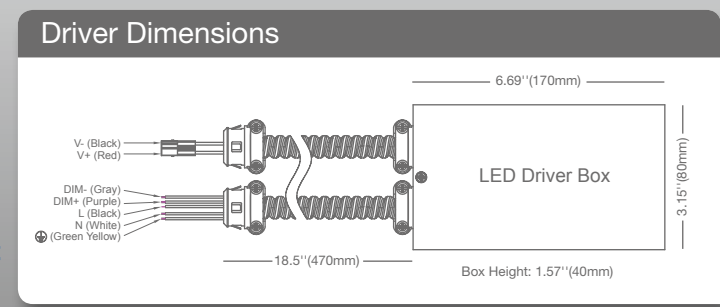

- Fits existing architectural and commercial housing
- 0-10V dimming – Compatible with 120-277V circuits
- Easy installation – Quick connector and pre-wired conduit
- Superior savings and performance over CFL

Trim Dimensions		
Model No.:	A	B
 48CDL9.5G4DIM/xxx/277V	9.25" (235mm)	6.50" (165mm)
 32CDL8G4DIM/xxx/277V	7.80" (197mm)	5.90" (150mm)
 22CDL6G4DIM/xxx/277V	6.02" (153mm)	5.39" (137mm)



SPECIFICATIONS*

Model	Product	CCT	Lumens (lm)	Equiv.	LPW	Beam Angle	CBCP (cd)	CRI (typ.)	Dim	Life (hrs)	Voltage	Encl.		
 CDL 9.5" 48W	48CDL9.5G4DIM/830/277V	97706	3000K	3000	2 X 42W	63	90°	N.A.	80	Yes	40,000	120-277V	No	July
	48CDL9.5G4DIM/835/277V	97707	3500K	3100	2 X 42W	65	90°	N.A.	80	Yes	40,000	120-277V	No	July
	48CDL9.5G4DIM/840/277V	97708	4000K	3250	2 X 42W	68	90°	N.A.	80	Yes	40,000	120-277V	No	July
 CDL 8" 32W	32CDL8G4DIM/830/277V	97696	3000K	2000	2 X 26W	63	90°	N.A.	80	Yes	40,000	120-277V	No	July
	32CDL8G4DIM/835/277V	97697	3500K	2100	2 X 26W	66	90°	N.A.	80	Yes	40,000	120-277V	No	July
	32CDL8G4DIM/840/277V	97698	4000K	2200	2 X 26W	69	90°	N.A.	80	Yes	40,000	120-277V	No	July
 CDL 6" 22W	22CDL6G4DIM/830/277V	97686	3000K	1400	2 X 18W	64	90°	N.A.	80	Yes	40,000	120-277V	No	July
	22CDL6G4DIM/835/277V	97687	3500K	1450	2 X 18W	66	90°	N.A.	80	Yes	40,000	120-277V	No	July
	22CDL6G4DIM/840/277V	97688	4000K	1500	2 X 18W	68	90°	N.A.	80	Yes	40,000	120-277V	No	July

* Specification data is preliminary and may be subject to change

FLUORESCENT EQUIVALENCE TABLE

9.5" - 48W	8" - 32W	6" - 22W
2X26W	2X18W	1X26W
2X32W	2X26W	2X18W
2X42W	2X32W	2X26W



Extra Wide Beam Design - End-to-End Lighting

Lamp Front View
Lamp Back View

GREEN CREATIVE
Other LED Tubes

Traditional Look - No Dark Spots

GREEN CREATIVE U-BENT LED
Other U-BENT LED

- Easy to install – Plug and Play Direct
- Compatible with Instant Start ballasts – No rewiring
- End-to-end lighting with no dark spots
- Suitable for use in totally enclosed fixtures



Extra Wide Beam Design - End-to-End Lighting

Lamp Front View
Lamp Back View

GREEN CREATIVE
Other LED Tubes

BYPass Installation - Single-Ended Connection

~~BALLAST~~ 120-277V UNIVERSAL

UL1598C classification ensures fixture maintains original UL compliance

- Built-in universal voltage driver – Bypass installation
- Wide beam design 325° light emitting area
- End-to-end lighting with no dark spots
- Suitable for use in totally enclosed fixtures

SPECIFICATIONS

Model	Product	CCT	Lumens (lm)	Equiv.	LPW	Beam Angle	CBCP (cd)	CRI (typ.)	Dim	Life (hrs)	Voltage	Encl.	DLC	
T8 17W 4FT. DIR	17T8G4/4F/840/DIR	40800	4000K	2050	32W	121	140°	N.A.	80	No	50,000	120-277V	Yes	✓
	17T8G4/4F/850/DIR	40801	5000K	2100	32W	124	140°	N.A.	80	No	50,000	120-277V	Yes	✓
T8 15W 4FT. DIR	15T8G4/4F/840/DIR	40796	4000K	1650	32W	110	140°	N.A.	80	No	50,000	120-277V	Yes	✓
	15T8G4/4F/850/DIR	40797	5000K	1700	32W	113	140°	N.A.	80	No	50,000	120-277V	Yes	✓
T8 10W 2FT. DIR	10T8G4/2F/840/DIR	40802	4000K	1050	17W	105	140°	N.A.	80	No	50,000	120-277V	Yes	N.A.
	10T8G4/2F/850/DIR	40803	5000K	1100	17W	110	140°	N.A.	80	No	50,000	120-277V	Yes	N.A.
T8 U-BENT 16W DIR	16T8U6G4/830/DIR	40707	3000K	1650	32W	103	160°	N.A.	80	No	50,000	120-277V	Yes	N.A.
	16T8U6G4/840/DIR	40848	4000K	1800	32W	113	160°	N.A.	80	No	50,000	120-277V	Yes	N.A.
	16T8U6G4/850/DIR	40849	5000K	1800	32W	113	160°	N.A.	80	No	50,000	120-277V	Yes	N.A.

SPECIFICATIONS

Model	Product	CCT	Lumens (lm)	Equiv.	LPW	Beam Angle	CBCP (cd)	CRI (typ.)	Dim	Life (hrs)	Voltage	Encl.	DLC	
T8 17.5W 4FT. BYP	17.5T8G4/4F/830/BYP (MTO)	40784	3000K	1900	32W	108	180°	N.A.	80	No	50,000	120-277V	Yes	✓
	17.5T8G4/4F/835/BYP (MTO)	40785	3500K	1900	32W	108	180°	N.A.	80	No	50,000	120-277V	Yes	✓
	17.5T8G4/4F/840/BYP	40786	4000K	2000	32W	114	180°	N.A.	80	No	50,000	120-277V	Yes	✓
	17.5T8G4/4F/850/BYP	40787	5000K	2000	32W	114	180°	N.A.	80	No	50,000	120-277V	Yes	✓
T8 15W 4FT. BYP	15T8G4/4F/840/BYP	40782	4000K	1800	32W	120	180°	N.A.	80	No	50,000	120-277V	Yes	✓
	15T8G4/4F/850/BYP	40783	5000K	1800	32W	120	180°	N.A.	80	No	50,000	120-277V	Yes	✓
T8 9W 2FT. BYP	9T8G4/2F/840/BYP	40788	4000K	1000	32W	111	180°	N.A.	80	No	50,000	120-277V	Yes	✓
	9T8G4/2F/850/BYP	40789	5000K	1000	32W	111	180°	N.A.	80	No	50,000	120-277V	Yes	✓

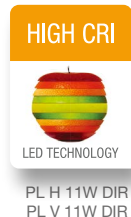
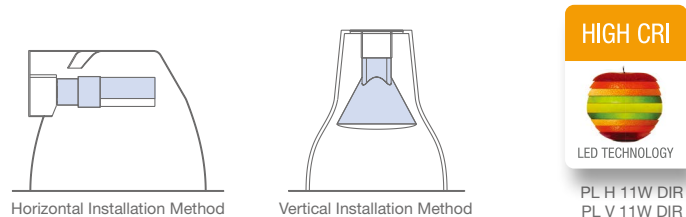

High Performance - Ballast Smart Control

Ballast Type	Lumens	Bare Lamp
13W	720	8W
18W	850	9.5W
26W	1000	11W

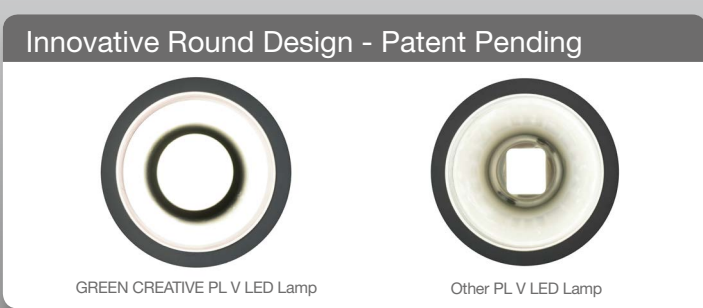

- Easy to install - Plug & Play Direct
- For use with 13W, 18W, 26W, 32W & 42W electronic ballasts
- Ballast smart control technology
- Compatible with G24q/GX24q installations

SPECIFICATIONS*

Model	Product	CCT	Lumens (lm)	Equiv.	LPW	Beam Angle	CBCP (cd)	CRI (typ.)	Dim	Life (hrs)	Voltage	Encl.	Energy Star	
PL H 11W DIR	11PLHG4/827/DIR	40817	2700K	850	26W	77	110°	N.A.	80	No	40,000	120-277V	No	Pending
	11PLHG4/830/DIR	40818	3000K	920	26W	84	110°	N.A.	80	No	40,000	120-277V	No	Pending
	11PLHG4/835/DIR	40819	3500K	950	26W	86	110°	N.A.	80	No	40,000	120-277V	No	Pending
	11PLHG4/840/DIR	40820	4000K	1000	26W	91	110°	N.A.	80	No	40,000	120-277V	No	Pending
	11PLHG4/850/DIR	40821	5000K	1000	26W	91	110°	N.A.	80	No	40,000	120-277V	No	Pending
PL H 11W DIR	11PLHG4/930/DIR	40823	3000K	800	26W	73	110°	N.A.	90	No	40,000	120-277V	No	Pending
PL V 11W DIR	11PLVG4/827/DIR	97669	2700K	850	26W	77	110°	N.A.	80	No	40,000	120-277V	No	Pending
	11PLVG4/830/DIR	97670	3000K	920	26W	84	110°	N.A.	80	No	40,000	120-277V	No	Pending
	11PLVG4/835/DIR	97671	3500K	950	26W	86	110°	N.A.	80	No	40,000	120-277V	No	Pending
	11PLVG4/840/DIR	97672	4000K	1000	26W	91	110°	N.A.	80	No	40,000	120-277V	No	Pending
	11PLVG4/850/DIR	97673	5000K	1000	26W	91	110°	N.A.	80	No	40,000	120-277V	No	Pending
PL V 11W DIR	11PLVG4/930/DIR	97675	3000K	800	26W	73	110°	N.A.	90	No	40,000	120-277V	No	Pending

* PL H 11W DIR and PL V 11W DIR specification data is preliminary and may be subject to change

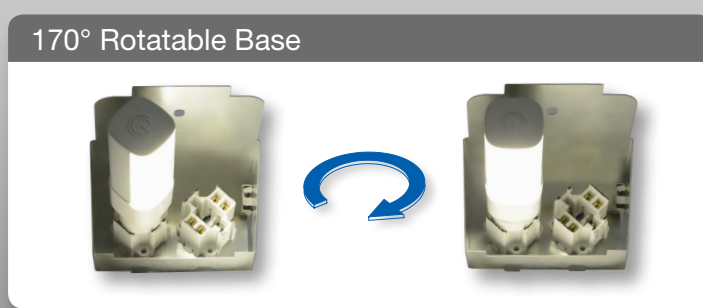
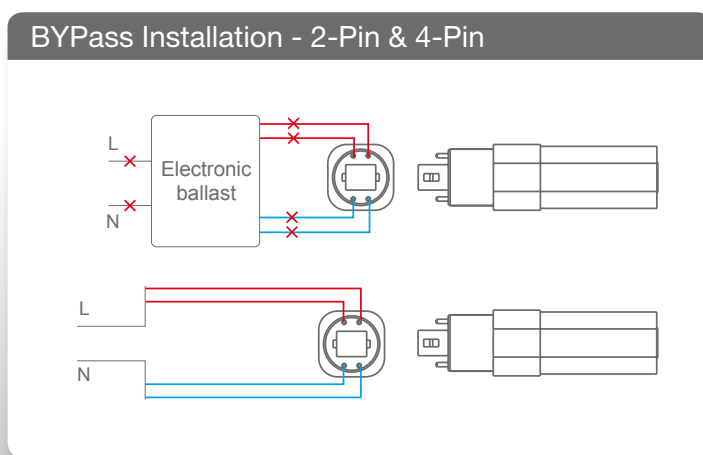
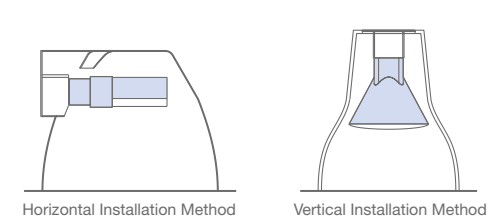

- Built-in universal voltage driver - Bypass installation
- Compatible with G24q/GX24q & G24d/GX24d installations
- High-quality diffuser for maximum light distribution
- Lasts 4 times longer than CFL

SPECIFICATIONS*

Model	Product	CCT	Lumens (lm)	Equiv.	LPW	Beam Angle	CBCP (cd)	CRI (typ.)	Dim	Life (hrs)	Voltage	Encl.	Energy Star	
PL H 11W BYP	11PLHG4/835/BYP	40816	3500K	950	26W	86	110°	N.A.	80	No	40,000	120-277V	No	Pending
	11PLHG4/840/BYP	40826	4000K	1000	26W	91	110°	N.A.	80	No	40,000	120-277V	No	Pending
	11PLHG4/850/BYP	40827	5000K	1000	26W	91	110°	N.A.	80	No	40,000	120-277V	No	Pending
PL V 11W BYP	11PLVG4/835/BYP	97681	3500K	950	26W	86	110°	N.A.	80	No	40,000	120-277V	No	Pending
	11PLVG4/840/BYP	97682	4000K	1000	26W	91	110°	N.A.	80	No	40,000	120-277V	No	Pending

* PL H 11W BYP and PL V 11W BYP specification data is preliminary and may be subject to change



High CRI Version Available in E26 and GU24 Bases



- ⌚ Omnidirectional: 300° beam angle
- ⌚ 40% more energy savings than CFL
- ⌚ Natural A-lamp shape fits all applications
- ⌚ Comfortable warm diffused light

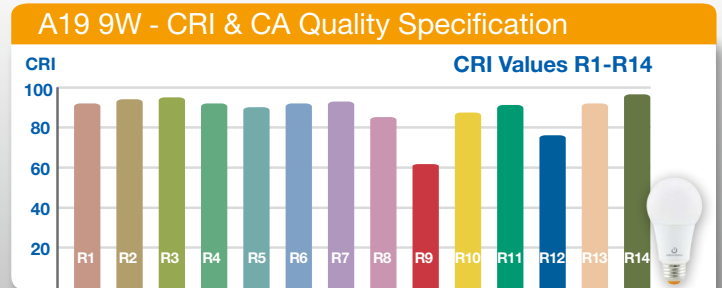





SPECIFICATIONS

Model	Product	CCT	Lumens (lm)	Equiv.	LPW	Beam Angle	CBCP (cd)	CRI (typ.)	Dim	Life (hrs)	Voltage	Encl.	Energy Star
A21 17W	17A21G4DIM/827	16179	2700K	1600	100W	94	330°	N.A.	80	Yes	25,000	120V	Yes ✓
	17A21G4DIM/830	16180	3000K	1650	100W	97	330°	N.A.	80	Yes	25,000	120V	Yes ✓
	17A21G4DIM/840	16181	4000K	1700	100W	100	330°	N.A.	80	Yes	25,000	120V	Yes ✓
A21 3-WAY 5.5/10.5/17W	17A21G4/827/3WAY	16335	2700K	500	40W	91	330°	N.A.	80	No	25,000	120V	No Aug.
				1000	75W	95	330°	N.A.	80	No	25,000	120V	No Aug.
A19 12W	12A19G4DIM/827	16175	2700K	1100	75W	92	330°	N.A.	80	Yes	25,000	120V	Yes ✓
	12A19G4DIM/830	16176	3000K	1150	75W	96	330°	N.A.	80	Yes	25,000	120V	Yes ✓
	12A19G4DIM/840	16177	4000K	1180	75W	98	330°	N.A.	80	Yes	25,000	120V	Yes ✓
A19 9W	9A19G4DIM/824	40741	2400K	700	60W	78	300°	N.A.	80	Yes	25,000	120V	No N.A.
	9A19G4DIM/827	40742	2700K	800	60W	89	300°	N.A.	80	Yes	25,000	120V	No ✓
	9A19G4DIM/830	40743	3000K	800	60W	89	300°	N.A.	80	Yes	25,000	120V	No ✓
	9A19G4DIM/840	40744	4000K	850	60W	94	300°	N.A.	80	Yes	25,000	120V	No ✓
A19 9W	9A19G4DIM/927	40746	2700K	800	60W	89	300°	N.A.	92	Yes	25,000	120V	No ✓

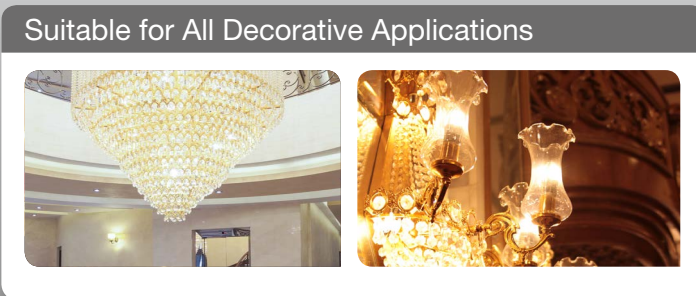

SPECIFICATIONS

Model	Product	CCT	Lumens (lm)	Equiv.	LPW	Beam Angle	CBCP (cd)	CRI (typ.)	Dim	Life (hrs)	Voltage	Encl.	Energy Star
A19 9W 277V	9A19G4/827/277V	40750	2700K	800	60W	89	300°	N.A.	80	No	25,000	120-277V	No ✓
	9A19G4/830/277V	40751	3000K	800	60W	89	300°	N.A.	80	No	25,000	120-277V	No ✓
	9A19G4/840/277V	40752	4000K	850	60W	94	300°	N.A.	80	No	25,000	120-277V	No ✓
A19 9.5W GU24	9.5A19G4DIM/827/GU24	40735	2700K	800	13W	84	300°	N.A.	80	Yes	25,000	120V	Yes ✓
	9.5A19G4DIM/830/GU24	40736	3000K	800	13W	84	300°	N.A.	80	Yes	25,000	120V	Yes ✓
	9.5A19G4DIM/840/GU24	40737	4000K	850	13W	89	300°	N.A.	80	Yes	25,000	120V	Yes ✓
A19 11W GU24	11A19G4DIM/927/GU24	40739	2700K	800	13W	73	300°	N.A.	80	Yes	25,000	120V	No ✓
A19 8.5W	8.5A19G4/827	40745	2700K	800	60W	94	220°	N.A.	80	No	25,000	120V	Yes N.A.
A19 6.5W	6.5A19G4DIM/827	40732	2700K	470	40W	72	300°	N.A.	80	Yes	25,000	120V	Yes ✓
	6.5A19G4DIM/830	40733	3000K	480	40W	74	300°	N.A.	80	Yes	25,000	120V	Yes ✓



-  Smooth dimming with existing installations
-  Omnidirectional: 275° beam angle
-  Available in 2400K CCT for warm atmosphere lighting
-  Compact heat sink blends in with fixtures

SPECIFICATIONS

Model	Product	CCT	Lumens (lm)	Equiv.	LPW	Beam Angle	CBCP (cd)	CRI (typ.)	Dim	Life (hrs)	Voltage	Encl.		
 B11 5W	5B11G4DIM/827/FR	40730	2700K	350	40W	70	275°	N.A.	82	Yes	25,000	120V	No	✓
 B11 4.5W	4.5B11G4DIM/824	40725	2400K	275	40W	61	275°	N.A.	83	Yes	25,000	120V	No	N.A.
	4.5B11G4DIM/827	40726	2700K	315	40W	70	275°	N.A.	83	Yes	25,000	120V	No	✓
 B11 4.5W E26	4.5B11G4DIM/827/E26	40728	2700K	315	40W	70	275°	N.A.	80	Yes	25,000	120V	No	✓

Bringing You the Latest in LED Technology





GREEN CREATIVE
220 South Spruce Ave., Suite 203
South San Francisco, CA 94080
Tel / Fax: (866) 774-5433
info@greencreative.com
www.greencreative.com

 / GREENCREATIVELED
 / GClightingLED
 / GREEN CREATIVE

