

Project: _____

Fixture Type: _____

Location: _____

Contact/Phone: _____

PRODUCT SPECIFICATIONS

Lamp (2) or (4) nominal 1-watt high output Nichia LEDs available in 85 CRI 3000K, 4100K or 5000K or 92 CRI 3000K • Rated lumens (listed below) and rated life of 50,000 hours at 70% of initial lumens based on testing of the DL106 and DL112 luminaires in a 25 degree C ambient environment with the LED junction temperatures measured below LED manufacturer's published maximums • On board constant current control circuit ensures that all LEDs will produce the same amount of light anywhere along the length of a run of fixtures.

Lens Clear or Frosted Polycarbonate.

Construction LED's are surface mounted on thermally conductive printed circuit board which is in direct contact with an extruded aluminum base for efficient thermal dissipation • Designed for even LED spacing over linear runs with no hot/dark spots between fixtures.

Finish Clear anodized aluminum.

Drivers Class 2, 24-volt DC electronic remote mount drivers (ordered separately) are available in wattages ranging from 17 to 100 watts • Allow 6 watt per foot.

Dimming DL106 and DL112 are dimmable with approved drivers and dimmers • See other side for details.

Labels UL/C-UL listed for use in dry locations.

Product specifications subject to change without notice.

INSTALLATION

Modular "plug-together" system for easy installation. Up to 16 one-foot fixtures (32 six-inch) can be joined together in a single run using either in-line connectors or jumper cables (ordered separately). One starter power cable and one end-cap required for each run (ordered separately).

Applications Applications include, but are not limited to, shelf and display lighting, under cabinet lighting, task lighting, cove lighting and hand rails.

Mounting Hardware One 3/4" (6" fixture), two 3/4" (12" fixture) long type A Phillips Pan Head screws suitable for mounting to wood or metal surfaces are supplied • Other mounting screws may be substituted as required to mount to other types of surfaces.

Optional Mounting Extrusions 1" high fascia and corner mounting extrusions (ordered separately).

DANALITE

MODULAR SLIM PROFILE LED DL106 and DL112 Series



DIMENSIONS

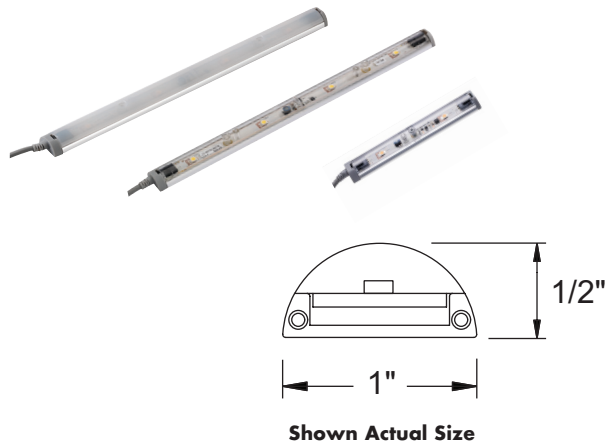

PRODUCT CODES

5 1/2" Slim LED Fixtures

Cat. #	CCT	CRI	Watts Typ Max		Lens	Fixture Lumens
DL106-3-C	3000K	85	2.5	3	Clear	85
DL106-4-C	4100K	85	2.5	3	Clear	111
DL106-5-C	5000K	85	2.5	3	Clear	131
DL106-3H-C*	3000K	92	2.5	3	Clear	70
DL106-3-F	3000K	85	2.5	3	Frosted	63
DL106-4-F	4100K	85	2.5	3	Frosted	80
DL106-5-F	5000K	85	2.5	3	Frosted	93
DL106-3H-F*	3000K	92	2.5	3	Frosted	50

1 1/2" LED Fixtures

Cat. #	CCT	CRI	Watts Typ Max		Lens	Fixture Lumens
DL112-3-C	3000K	85	5	6	Clear	170
DL112-4-C	4100K	85	5	6	Clear	222
DL112-5-C	5000K	85	5	6	Clear	263
DL112-3H-C*	3000K	92	5	6	Clear	140
DL112-3-F	3000K	85	5	6	Frosted	126
DL112-4-F	4100K	85	5	6	Frosted	161
DL112-5-F	5000K	85	5	6	Frosted	187
DL112-3H-F*	3000K	92	5	6	Frosted	100

*High CRI

Electrical Feeds & Connectors (order separately)

Catalog No.	Description
DL101-P	118" Starter Power Cable (power to 1st module)
DL101-E	End Cap
DL102-EE	End to End Connector
DL102-FLX2	2 1/2" Flexible End to End Connector
DL102-FLX37	37 1/2" Flexible End to End Connector
DL101-TB**	Terminal Block Connector

**Accepts solid or stranded 2 or 3 conductor cable (incl. ground), 14 - 20AWG

DANALITE

MODULAR SLIM PROFILE LED DL106 and DL112 Series

Non-Dimmable Enclosed Electronic Drivers with integral switch

(order separately) - No minimum load on drivers

Catalog No.	Description
DLD-17-120-WH	17W Remote 24VDC (120V input)
DLD-17-120-BL	17W Remote 24VDC (120V input)
DLD-25-WH	25W Remote 24VDC (120-277V input)
DLD-25-BL	25W Remote 24VDC (120-277V input)
DLD-80-120*	80W Remote 24VDC (120V input)
DLD-100*	100W Remote 24VDC (120-277V input)

*Finish: Natural Aluminum.

Finish: WH-White, BL-Black.

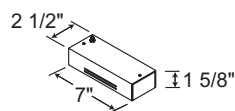

(DLD-17 / DLD-25)

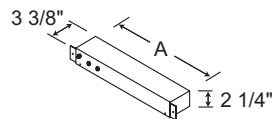

(DLD-80 / DLD-100) A=16"
(DLD-17-120-DIM / DLD-25-DIM) A=9"
(DLD-60-DIM / DLD-100-DIM) A=16"

Dimmable Enclosed Electronic Drivers with integral switch

(order separately) - No minimum load on drivers

Catalog No.	Description
DLD-17-120-DIM	17W 24VDC (120V input)
DLD-25-DIM	25W 24VDC (120-277V input)
DLD-60-DIM	60W 24VDC (120-277V input)
DLD-100-DIM	100W 24VDC (120-277V input)

Finish: Natural Aluminum.

Approved Dimmers

Lutron Model No. Leviton Model No.

NTF-10 IP710-DLX

NTF-10-277

Consult Technical Services or the factory for additional dimmers.

Mounting Extrusion Accessories (order separately)

Catalog No.	Description
DL103-MS48-S	48" Extruded Mounting Shield Satin Aluminum
DL103-MS96-S	96" Extruded Mounting Shield Satin Aluminum
DL103-AME48-S	48" Angle Mounting Extrusion Satin Aluminum
DL103-AME96-S	96" Angle Mounting Extrusion Satin Aluminum

Shield (DL103-MS)

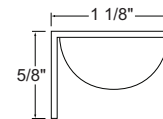

45° Angle Mount (DL103-AME)

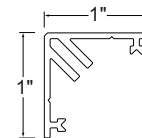

Factory Installed Cord & Plug Option

(Add suffix to driver - Non dimming only)

Suffix	Description
-CP6WH	6 Ft cord w/3-prong plug, white, 120V, 3A
-CP6BL	6 Ft cord w/3-prong plug, black, 120V, 3A

Example: DLD-25-WH-CP6WH

ELECTRICAL FEEDS & CONNECTORS (order separately)

END FEEDS

One DL101-P or DL101-TB required per run.



DL101-P
118" Starter Power Cable (power to 1st fixture). Can be field shortened or extended.

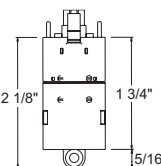

DL101-TB

Terminal Block Connector.

Plugs into end of LED fixture and accepts 14 through 20 gauge stranded or solid insulated wire or cable including non-metallic sheathed cable, SPT-2 lamp cord or speaker wire (supplied by others). May also be used in pairs to create custom length jumper cables.

END CAPS

One required per run.



DL101-E
End cap

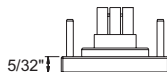

JOINER CONNECTORS

One DL102-EE or one DL102-FLX required for each fixture to fixture connection.



DL102-EE
End-to-end connector

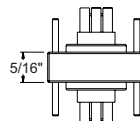

DL102-FLX2
2 1/2" flexible end-to-end connector

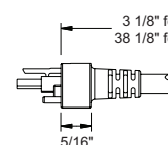

DL102-FLX37
37 1/2" flexible end-to-end connector

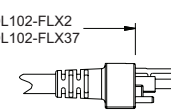

1300 S. Wolf Road • Des Plaines, IL 60018 • Phone (847) 827-9880 • Fax (847) 827-2925
220 Chrysler Drive • Brampton, Ontario • Canada L6S 6B6 • Phone (905) 792-7335 • Fax (905) 792-0064
Visit us at www.junolightinggroup.com

Printed in U.S.A. ©2009 Juno Lighting, LLC.

DANALITE**MODULAR SLIM PROFILE LED
DL106 and DL112 Series****MOUNTING EXAMPLES**

(2) Danalite LED fixtures with power cable, end-to-end connector and end cap

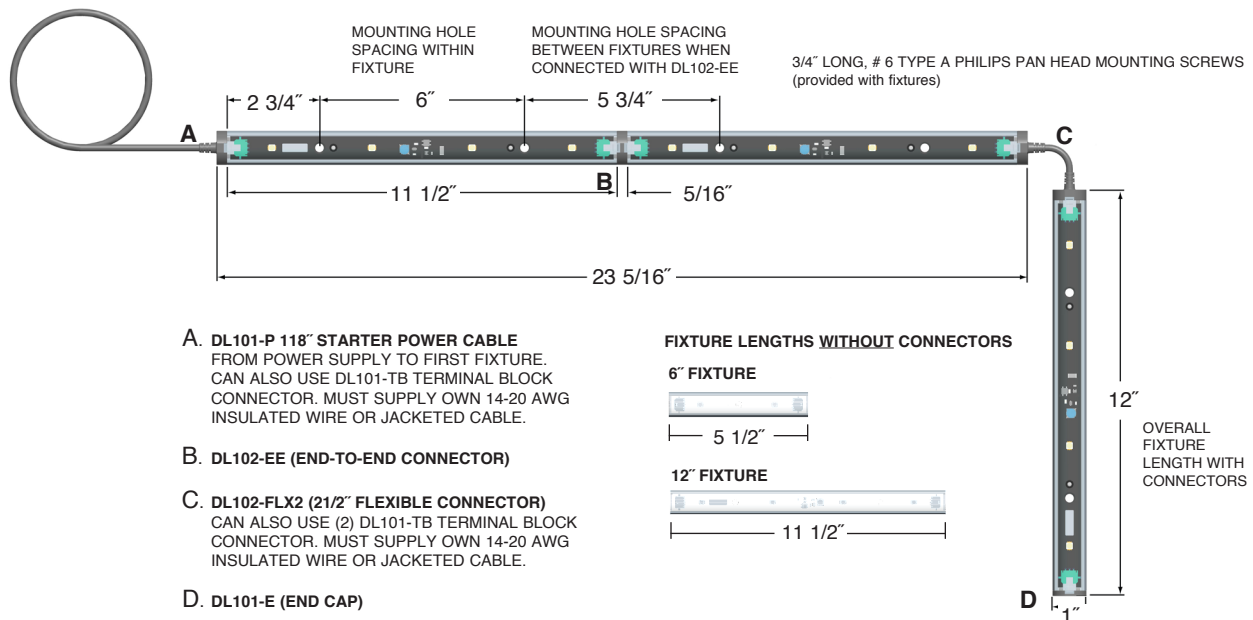

(2) Danalite LED fixtures with power cable, flexible connector and end cap

MECHANICAL DIMENSIONS - BASED ON 12" FIXTURES**Maximum Starter Cable Length from driver to first fixture (feet)**

# of Fixtures in Run	Joiner Type	Maximum Starter Cable Length from driver to first fixture (feet)		
		20 Gauge	18 Gauge	14 Gauge
<8	DL102-EE	100	100	100
	DL102-FLX2	100	100	100
	DL102-FLX37	100	100	100
8	DL102-EE	95	100	100
	DL102-FLX2	93	100	100
	DL102-FLX37	85	100	100
10	DL102-EE	71	100	100
	DL102-FLX2	66	100	100
	DL102-FLX37	58	92	100
12	DL102-EE	52	83	100
	DL102-FLX2	46	73	100
	DL102-FLX37	32	51	100
14	DL102-EE	37	59	100
	DL102-FLX2	33	52	100
	DL102-FLX37	—	36	100
16	DL102-EE	25	40	100
	DL102-FLX2	—	35	100
	DL102-FLX37	—	27	100

DANALITE

MODULAR SLIM PROFILE LED

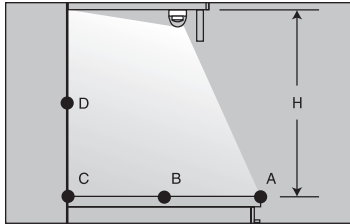
DL106 and DL112 Series**PHOTOMETRICS****Cabinetry Lighting Photometrics****Footcandles on Horizontal Work Surface**

LED CCT	Cat No.	Volts/Watts	Mounting Height (H)	Footcandles			
				A	B	C	D
3000K	DL112-3-C	24V/5.3W	6"	10	155	15	20
			15"	15	36	22	23
			18"	13	26	19	20
			24"	10	15	13	16
4100K	DL112-4-C	24V/5.3W	6"	14	212	22	26
			15"	20	48	30	32
			18"	18	35	25	26
			24"	13	21	18	21
5000K	DL112-5-C	24V/5.3W	6"	16	246	28	34
			15"	24	56	36	39
			18"	21	40	30	31
			24"	16	24	21	26
3000K, High CRI	DL112-3H-C	24V/5.3W	6"	9	132	14	17
			15"	13	31	19	20
			18"	11	22	16	16
			24"	9	13	11	14

Frosted Lens Multiplier = 0.75

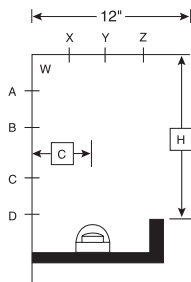
Cove Lighting Photometrics**Footcandles on Horizontal and Vertical Planes**

LED CCT	Cat No.	Lamp Spacing from Wall (C)	Cove Height (H)	Footcandles on Vert. Plane (Wall)					Footcandles on Horiz. Plane (Ceiling)		
				A	B	C	D	W	X	Y	Z
3000K	DL112-3-C	3"	6"	95	136	168	89	142	155	112	66
		3"	9"	50	76	146	74	89	92	76	51
		3"	12"	29	48	111	62	58	59	53	40
		4"	6"	99	125	126	47	122	150	131	76
		4"	9"	54	81	112	32	82	89	81	56
		4"	12"	32	50	102	26	55	58	53	42
		5"	6"	95	102	93	37	102	137	140	88
		5"	9"	56	78	88	24	73	85	82	62
		5"	12"	34	52	82	19	52	57	54	45
		4100K	DL112-4-C	3"	6"	131	180	214	104	186	208
3"	9"			67	103	193	91	119	123	102	69
3"	12"			39	63	148	75	77	80	70	54
4"	6"			135	167	179	59	162	204	175	106
4"	9"			73	109	148	41	109	121	107	76
4"	12"			43	68	137	34	74	78	71	57
5"	6"			130	135	135	49	137	184	186	122
5"	9"			75	103	120	32	97	114	109	85
5"	12"			46	71	106	25	68	76	72	60
5000K	DL112-5-C			3"	6"	153	213	268	133	224	244
		3"	9"	77	119	240	110	140	143	119	82
		3"	12"	44	70	173	98	90	92	82	63
		4"	6"	154	196	214	68	193	237	202	123
		4"	9"	84	126	177	48	128	140	124	89
		4"	12"	49	77	163	40	86	92	83	66
		5"	6"	152	160	149	59	161	217	216	143
		5"	9"	87	123	147	38	114	133	125	97
		5"	12"	54	84	123	30	79	88	83	70
		3000K High CRI	DL112-3H-C	3"	6"	83	116	143	73	122	132
3"	9"			42	64	125	55	75	78	66	44
3"	12"			24	39	97	52	49	50	45	34
4"	6"			86	106	107	38	103	127	113	67
4"	9"			46	69	95	27	69	76	69	49
4"	12"			27	44	87	22	46	50	46	37
5"	6"			82	86	75	32	87	116	121	79
5"	9"			48	66	73	20	61	72	70	55
5"	12"			29	45	68	16	43	48	46	39

Frosted Lens Multiplier = 0.75

