

# Solais Lighting | LR38 LED Lamp

## Solais LED PAR38 Lamp Replacement

**Product Description:** The Solais active LED PAR38 lamp replacement has the high light output, light weight and full dimming capabilities of halogen incandescent sources – resulting in a high-performance product perfect for commercial, museum, retail and hospitality applications.

**Performance Summary:** Fully dimmable | Halogen PAR form factor (ANSI compliant) | Lightest LED lamps on the market | Certified to UL Standard 1993 | RoHS-compliant | Contain no lead or mercury | Dry location rating

**Application:** Designed for use in track and recessed fixtures (including IC rated housing)

**Voltage:** 120 V Standard (277 V available on some configurations; Check with manufacturer for details.)

**Dimmable:** Yes - Visit [solais.com/dimming.php](http://solais.com/dimming.php) for compatibility list

**Life:** 50,000 Hours (L70)

**Power Factor:** .92

**Base Type:** E26, GU24\*

**Weight (oz.):** 9.4



Product Code	Power (Watts)	Beam Angle	CCT (K)	Lumen Output	CBCP (cd)	CRI	ENERGY STAR®
LR38/25/30K/2100/___	28	25°	3000	2100	10700	83	
LR38/40/30K/2100/___	28	40°	3000	2100	4200	83	
LR38/25/27K/2000/___	28	25°	2700	2000	10200	83	
LR38/40/27K/2000/___	28	40°	2700	2000	4000	83	
LR38/15/30K/1600/___	24	15°	3000	1600	13100	83	
LR38/25/30K/1600/___	21	25°	3000	1600	8150	83	
LR38/40/30K/1600/___	21	40°	3000	1600	3200	83	
LR38/15/30K/1450/___	21	15°	3000	1450	11875	83	
LR38/25/30K/1450/___	20	25°	3000	1450	7400	83	
LR38/40/30K/1450/___	20	40°	3000	1450	2900	83	
LR38/15/27K/1450/___	21	15°	2700	1450	11875	85	
LR38/25/27K/1450/___	21	25°	2700	1450	7400	85	
LR38/40/27K/1450/___	21	40°	2700	1450	2900	85	
LR38/10/30K/1250/___*	18	10°	3000	1250	25875	83	
LR38/15/30K/1250/___	18	15°	3000	1250	10250	83	
LR38/25/30K/1250/___	18	25°	3000	1250	6375	83	
LR38/40/30K/1250/___	18	40°	3000	1250	2500	83	
LR38/10/27K/1250/___*	18	10°	2700	1250	25875	85	
LR38/15/27K/1250/___	18	15°	2700	1250	10250	85	
LR38/25/27K/1250/___	18	25°	2700	1250	6375	85	
LR38/40/27K/1250/___	18	40°	2700	1250	2500	85	

Housing Color: White (WH), Silver (SL), and Black (BK)

\* Made to Order

## Lamp Images

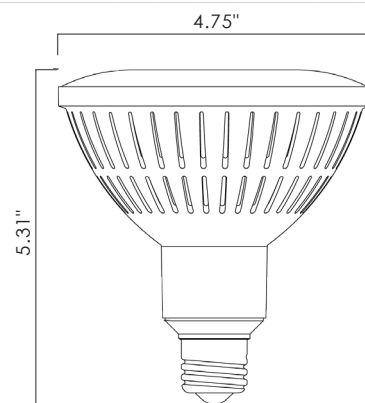

## Beam Angles

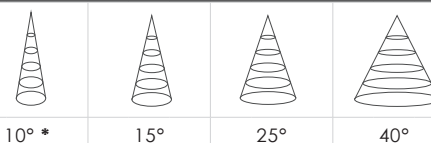

## Color Temperature

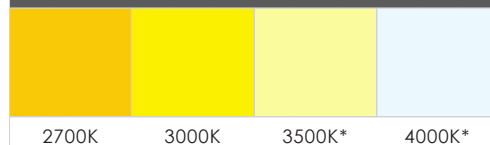

## Housing Colors

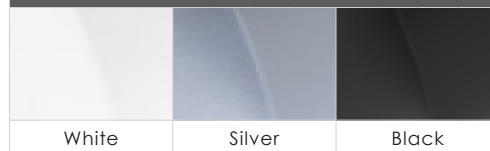

## Ordering Example LR38/25/30K/1250/SL

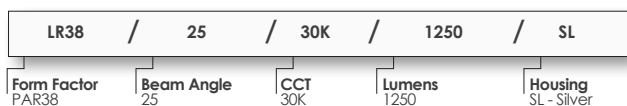



# Solais Lighting | LR38 LED Lamp

**LUXIANCE**<sup>®</sup>  
powered by SOLAIS

Luxiance utilizes active cooling to remove heat from the LED system - allowing Solais LED lamps to operate cooler, resulting in superior life, light output, and performance.

**THEROTTLE**<sup>™</sup>  
powered by SOLAIS

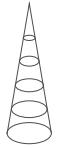
Thermal Throttle – In the event that Solais LEDs become overheated, they will dim themselves to protect your technology investments.

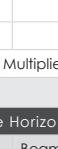
10° (Spot)   1250 lumens						
Candela Distribution	Degree	Candela		0° Aiming Angle Horizontal Footcandles		
				Distance to Floor	Beam Diameter	Avg. Beam Illuminance on Floors (FC)
	0	25875		6'	1.6'	621
	5	14462		8'	2.1'	349
	15	464		10'	2.6'	223
	25	61		12'	3.1'	155
	35	33		14'	3.7'	114
	45	31				
15° (Spot)   1600 lumens						
Candela Distribution	Degree	Candela		0° Aiming Angle Horizontal Footcandles		
				Distance to Floor	Beam Diameter	Avg. Beam Illuminance on Floors (FC)
	0	13100		6'	1.6'	304
	5	10512		8'	2.1'	171
	15	1009		10'	2.6'	109
	25	74		12'	3.1'	76
	35	31		14'	3.7'	56
	45	29				
Multipliers are as follows: 1450 lumens: 0.91   1250 lumens: 0.86						
25° (Narrow Flood)   2100 lumens						
Candela Distribution	Degree	Candela		0° Aiming Angle Horizontal Footcandles		
				Distance to Floor	Beam Diameter	Avg. Beam Illuminance on Floors (FC)
	0	10700		6'	2.3'	229
	5	9296		8'	3.1'	129
	15	2634		10'	3.9'	82
	25	260		12'	4.7'	57
	35	85		14'	5.5'	42
	45	61				
Multipliers are as follows: 2000 lumens: 0.95   1600 lumens: 0.76   1450 lumens: 0.69   1250 lumens: 0.60						
40° (Wide Flood)   2100 lumens						
Candela Distribution	Degree	Candela		0° Aiming Angle Horizontal Footcandles		
				Distance to Floor	Beam Diameter	Avg. Beam Illuminance on Floors (FC)
	0	4200		6'	4.4'	100
	5	4153		8'	5.8'	56
	15	3418		10'	7.3'	36
	25	1374		12'	8.7'	25
	35	534		14'	10.2'	18
	45	208				
Multipliers are as follows: 2000 lumens: 0.95   1600 lumens: 0.76   1450 lumens: 0.69   1250 lumens: 0.60						

**LIMITED WARRANTY:** Solais Lighting warrants that our lamps and fixtures will operate for a period of five (5) years from the date of purchase or 25,000 hours, whichever comes first, when used in accordance with package and lamp directions. If your Solais product does not last for the warranty period, please send your name and address, the product you are returning, register receipts and proof of purchase to the address listed on our website. This limited warranty does not cover products subject to misuse, electrical current fluctuation, accident, neglect, or acts of God. THIS REPLACEMENT OR REPAIR IS THE SOLE WARRANTY OBLIGATION OF SOLAIS AND IS IN LIEU OF ALL OTHER WARRANTIES, EXPRESS OR IMPLIED, INCLUDING ANY WARRANTY OF MERCHANTABILITY OR FITNESS FOR A PARTICULAR PURPOSE. LIABILITY FOR INCIDENTAL AND CONSEQUENTIAL DAMAGES EXCLUDED.

For complete warranty terms and conditions, please see: [www.solais.com/warranty](http://www.solais.com/warranty)

**WARNING:** Not for use in fully enclosed luminaires. Risk of electric shock. Use in an indoor, dry location only. This device is not intended for use with emergency exit fixtures or emergency exit lights. May not be compatible with all dimmers; please visit [solais.com/dimming](http://solais.com/dimming) for up-to-date dimmer compatibility information.

**NOTES:** This device complies with Part 15 of the FCC Rule. This product may cause interference with other devices. If interference occurs, change the locations of the products involved. **Compatible on 120v and 277v systems.**